

Position	Qty.	Description
	1	<p>SQF 1.2-2 N</p>  <p>Note! Product picture may differ from actual product</p> <p>Product No.: 95027419 The 3" SQFlex pump with helical rotor is for high heads and low flow rates.</p> <p>The SQFlex system is a reliable water supply system based on renewable energy sources, such as solar and wind energy. Thanks to its flexible energy supply and performance, the SQFlex system can be combined and adapted to meet any need on the installation site.</p> <p>The SQFlex system has a wide voltage range, built-in maximum power point tracking (MPPT) as well as dry-running, voltage and overload protection.</p> <p>Liquid: Pumped liquid: Water Maximum liquid temperature: 40 °C Liquid temp: 20 °C Density: 998.2 kg/m³</p> <p>Technical: Approvals on motor nameplate: CE</p> <p>Materials: Pump: Stainless steel DIN W.-Nr. 1.4401 AISI 316 Impeller: DIN W.-Nr. 1.4401</p> <p>Installation: Maximum ambient pressure: 15 bar Pump outlet: Rp 1 1/4 Minimum borehole diameter: 76 mm</p> <p>Electrical data: Motor type: MSF3N Power input - P1: 1.4 kW Rated voltage ac: 1 x 90-240 V Rated voltage dc: 30-300 V Start. method: direct-on-line Rated current: 8.4 A Power factor: 1 Rated speed: 500-3600 rpm Enclosure class (IEC 34-5): IP68 Insulation class (IEC 85): F Length of cable: 2 m</p>



Company name:

Created by:

Phone:

Date:

2/19/2016

Position	Qty.	Description
		<p>Others: Minimum efficiency index, MEI : -.-- Net weight: 7.9 kg Gross weight: 9.7 kg Shipping volume: 0.024 m³</p>



Company name:
Created by:
Phone:

Date: 2/19/2016

95027419 SQF 1.2-2 N 50 Hz

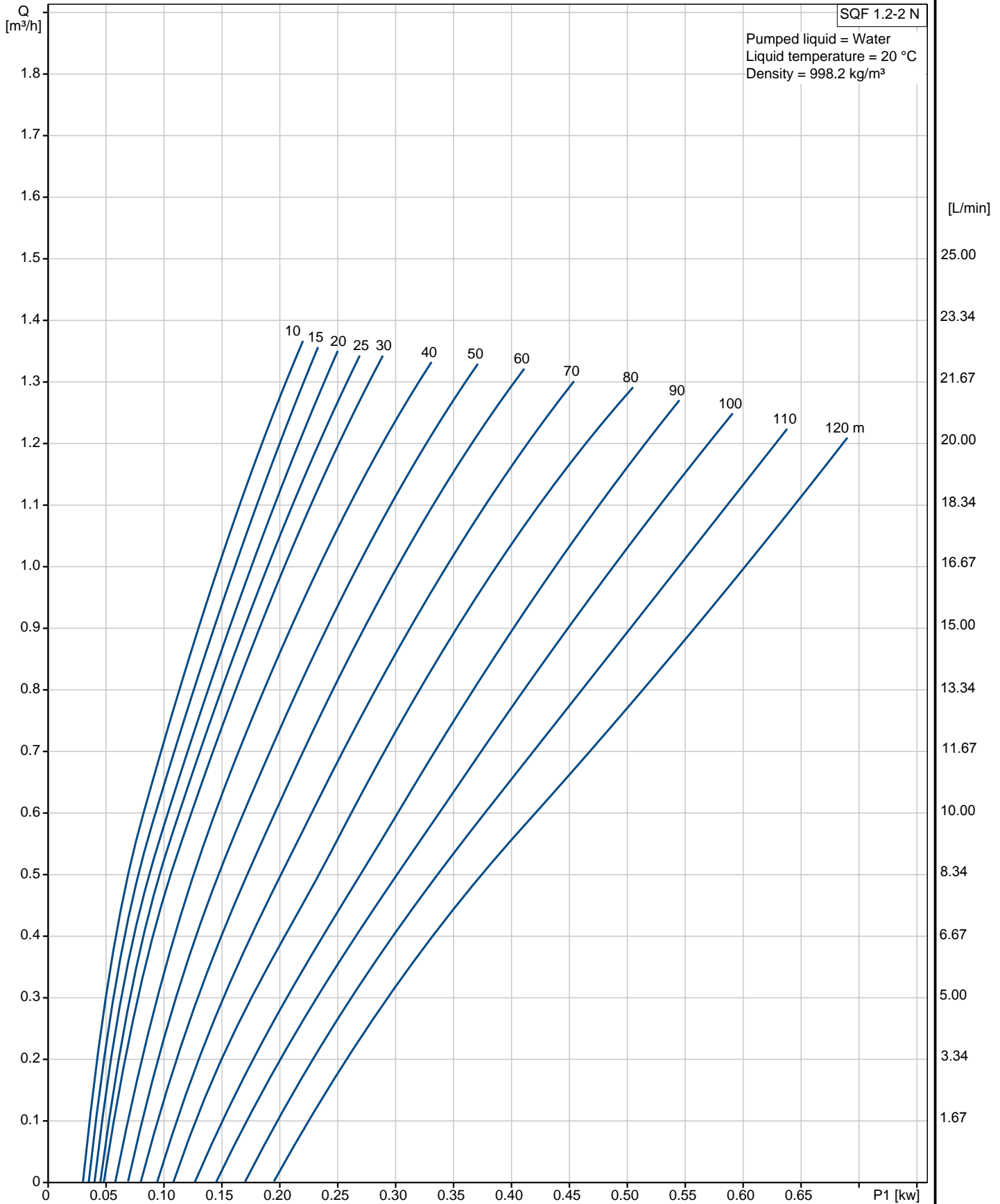

95027419 SQF 1.2-2 N 50 Hz

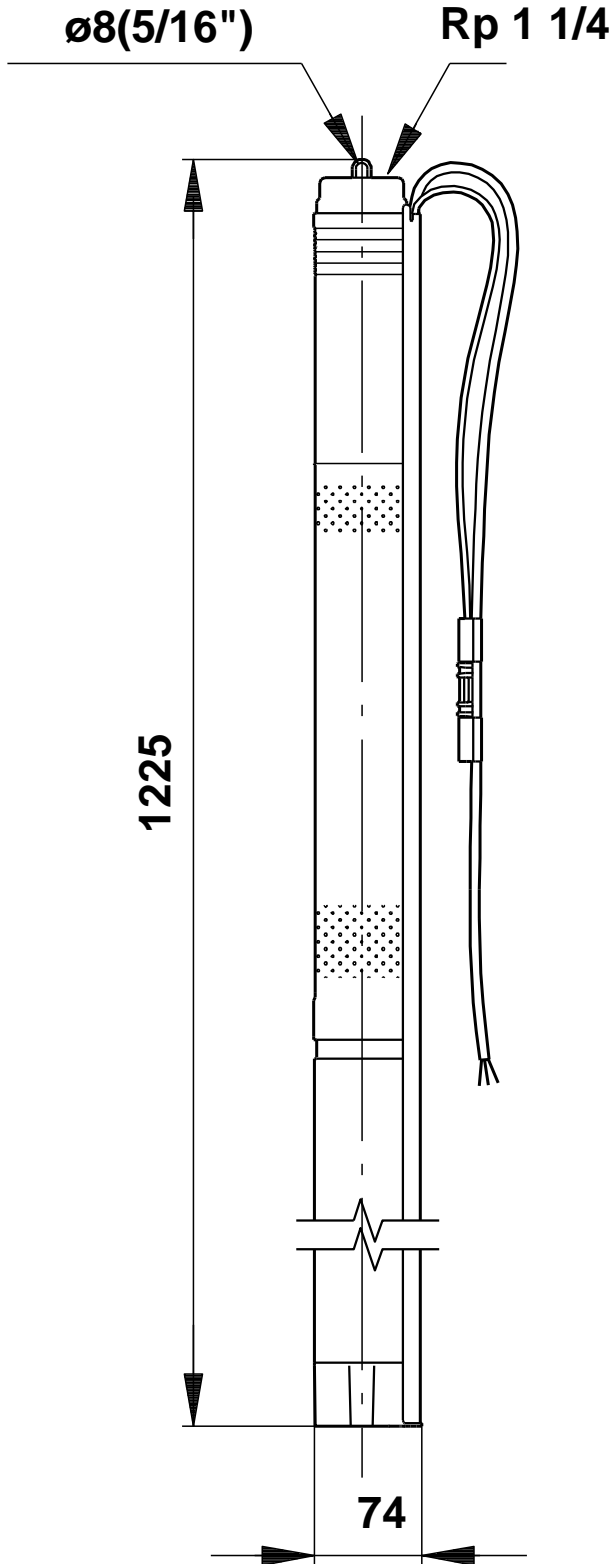

Note! All units are in [mm] unless others are stated.
Disclaimer: This simplified dimensional drawing does not show all details.